

B2-03430-00206

Instruction Manual

Model: TH-0343

Electronic Thermostat

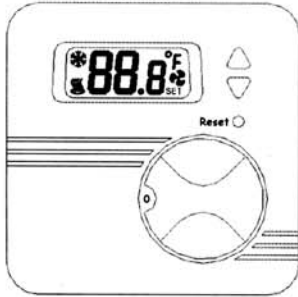

Installation

1. Look for a location, which has a constant temperature in the house and it, is not near the door entry or air condition outlet (see example on Figure 1).

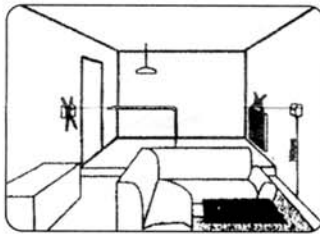

2. **Warning!!** Must remember to turn off your main power switch before installation the thermostat.

3. Disconnecting the front cover by using your hand pressing a hook on the top of the front cover.(see Figure 2). Pull the front cover out with your hand holding on two sides of the cover .

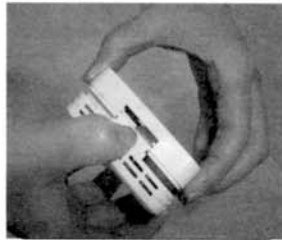

Figure 2

4. Mount the base with the wire through the hole of the base and mount the base with screwdriver on the wall.(see Figure 3).

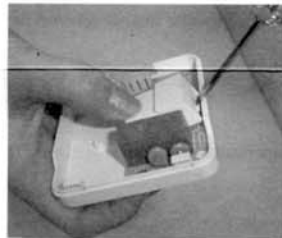

Figure 3

5. Install the wires into the terminal block with a screwdriver to tighten the screw top of terminal block (see figure 4). Before wiring, you **MUST** check your system-wiring diagram. If your system is other than this type, please consult with your local dealer or a profession electrician.



Figure 4

6. Install 2 AA size batteries then cover the front cover back to the base and make sure the hooks on the base are locked with front cover.
7. You can turn on the main power switch for operation

Wiring Diagram: Figure 5

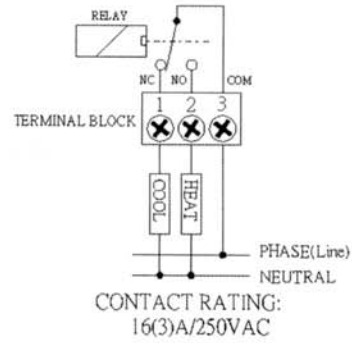

CONTACT RATING:
16(3)A/250VAC

TH-0343

Key Function:

Increase Temperatures

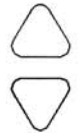

Decrease Temperatures



Increase Temperature

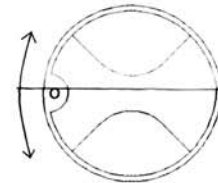

Decrease Temperature

Manual temperature set setback
Rotary knob

Setting and Operation

1. Press either ▲ or ▼ and LCD display will appear a flashing temperature with "Temperature Set" symbol .
2. Press again either ▲ or ▼ to set a desired temperature. Every press on ▲ will increase 1 °C and every press on ▼ will decrease 1 °C.
3. When you complete setting your desired temperature, please wait for 15 seconds until the LCD display stops flashing and then the thermostat starts to operate. When the room temperature reaches your desired setting, the unit will function to maintain the set temperature.
4. When batteries are running low, the LCD will display a "LO" symbol. Please follow the instructions on the left of this page to have the batteries replaced.



5. Temperature differential setting: Press both ▲ and ▼ knob for 5

seconds, then the LCD displays a **dif** symbol, do not

release the knobs, keep pressing on them for another 5 seconds, then

the LCD displays 0.6 °C , now you may press the ▲ knob or

the ▼ knob to have the setting changed from 0.4 °C to 1.0 °C